

Grade
STYLE 'A'
Post Mounted

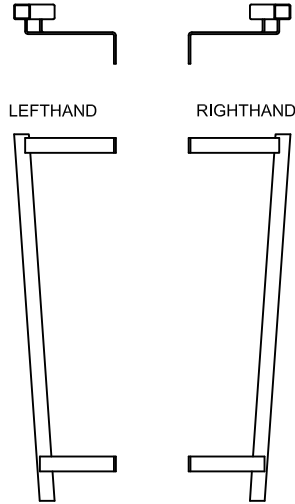

STYLE 'C'
Offset Wall or Post Mounted

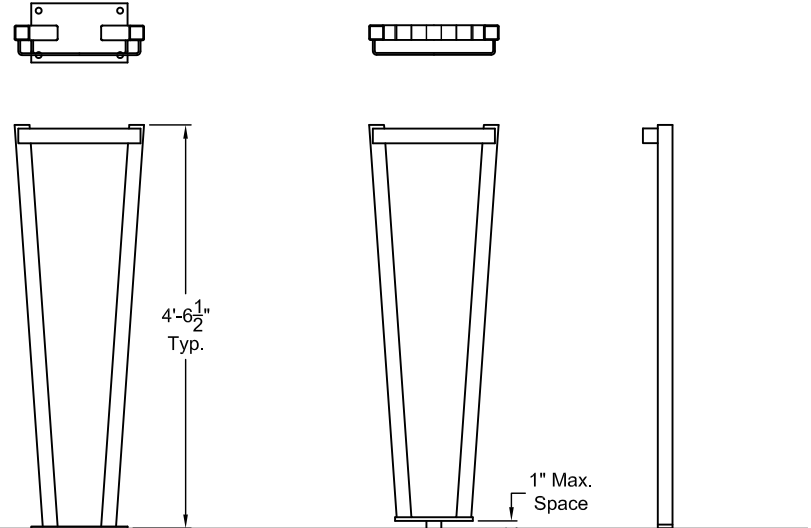

STYLE 'E'
Standard Pad Mounted

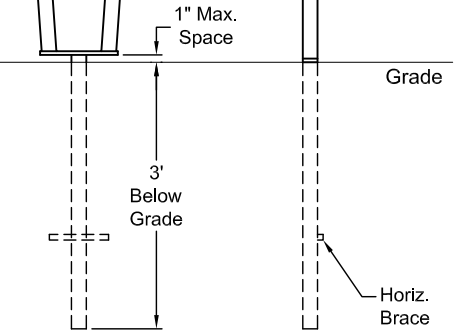

STYLE 'G'
Buried in Ground

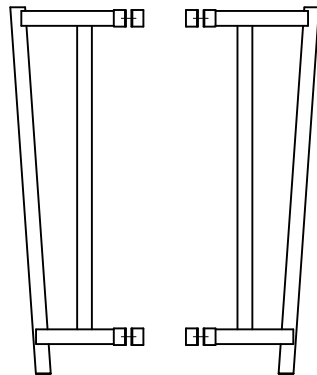
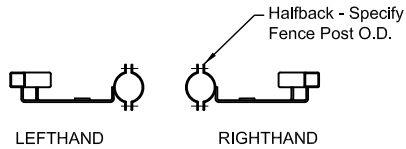

Grade
STYLE 'B'
Post Mounted

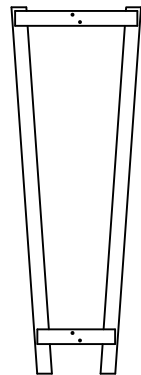

STYLE 'D'
Wall or Post Mounted

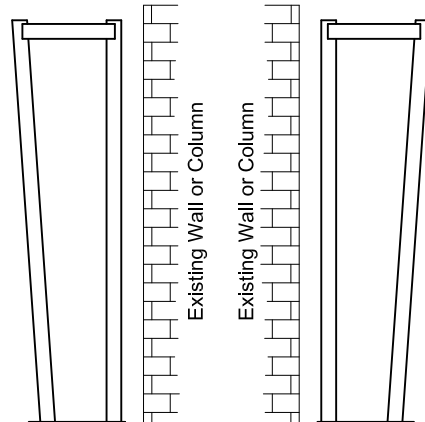

STYLE 'F'
Gate Perpendicular to Wall

NOTES:

- 1) All of these standard yokes are 5' tall.
- 2) Style 'G' protrudes an additional 36" in the ground.
- 3) Styles 'A' through 'D' is mounted 5" above grade.
- 4) Unless specified, gate is furnished with Style 'E'.

DO NOT SCALE

Rev.:	Description:	Date:
A	Conduit locations were moved outside the pad	07/18/08 MS
B	Added flat bar to Style "B" yokes	08/27/10 MS

NOTICE
THE INFORMATION CONTAINED ON THIS DOCUMENT IS CONFIDENTIAL. ANY DISSEMINATION, UNAPPROVED DISCLOSURE OR COPYING OF THIS INFORMATION IS STRICTLY PROHIBITED.
UNLESS OTHERWISE SPECIFIED DIMENSIONS ARE IN INCHES ANGLES ± 1°
X/X ± 1/32, .XX ± .01, .XXX ± .005

Date: 12/21/05
Drn. By: MKS
Superceded: 7/8/04
Dwg.: 105
Title: YOKE STYLES (5' STANDARD)

